

ELEMENT₄

USER MANUAL (2019)



CONTENTS

IMPORTANT SAFETY INFORMATION

Important safety information.....	4
-----------------------------------	---

HANDSET

Technical Data	5
General Notes	5

10 BUTTON REMOTE

Setting Fahrenheit or Celsius	6
Setting the Time	6
Child Proof	6
Manual Mode	7
Designated Low Fire and High Fire	7
Countdown Timer	7
Modes of Operation	ì
Thermostatic Mode	È..... ì
Program Mode	È..... ì
Auxiliary Feature (2nd Burner Feature)	È..... J
Eco Mode	È..... J
Circulating Fan Operation	È..... J
Light/Dimmer Operation	È F€
ProControl App.....	F€

THE PUCK

Technical Data	F€
Connecting the remote with the puck	FF
Modes of Operation	FF

WI-FI BOX

Technical Data	FG
Modes of Operation	FG

WI-FI BOX RGB LEDs AND EXTERNAL LED DRIVER

Technical Data	FH
External LED driver	FH

PROCONTROL APP SETUP

Initial Setup	25
KWIK Connect	25
Standard Setup	25

IMPORTANT SAFETY INFORMATION

▲ WARNING

Read these instructions carefully and completely before installing or operating. Failure to follow them could result in a fire or explosion causing property damage, personal injury, or loss of life. Service and installation must be performed by a trained / experienced service technician.

WHAT TO DO IF YOU SMELL GAS

- Do NOT operate any appliance.
- Do NOT touch any electrical switch; do NOT use any phone in your building.
- Immediately evacuate the area and contact the gas supplier. Follow the gas supplier's instructions.
- If you cannot reach the gas supplier, call the fire department.

Installation and service must be performed by a qualified installer, service agency, or the gas supplier. Installation shall conform with local codes, or in the absence of local codes, in accordance with the National Fuel Gas Code ANSI Z223.1 / NFPA 54 or the IFGC or CSA B149.1. All piping and tubing must comply with local codes and ordinances.

Use only your hand to push in or turn the gas control knobs. Never use tools. If a knob will not push in or turn by hand, do not try to repair it. Call a qualified service technician. Force or attempted repair can result in a fire or explosion.

Do NOT use a product if you suspect it has been subjected to high temperatures, damaged, tampered with, or taken apart.

Do NOT use a product if you suspect it has been under water or that liquid has seeped into the product. Any of these incidents can cause leakage or other damage that may affect proper operation and cause potentially dangerous combustion problems.

Damper position must be in accordance with Manufacturer's Installation Instructions and all applicable standards. Failure to follow them could result in a fire or explosion causing property damage, personal injury, or loss of life.

Do NOT store or use gasoline or other flammable vapors and liquids in the vicinity of this control or other appliances.

▲ WARNING

ELECTRIC SHOCK HAZARD

- Read these instructions carefully. Failure to follow them could result in property damage, personal injury, or loss of life.
- This control must be electrically wired and operated in accordance with all codes and local regulations. Service and installation must be performed by a trained, experienced service technician.
- Do NOT use the control if you suspect it may be damaged.

HANDSET

The Symax system combines new technology and a modern design with ease of operation. Instead of scrolling through a confusing menu, each function can now be activated by touching a symbol. Many remote controls on the market have few buttons and require extensive programming to operate.

The Symax System uses the same easy-to-operate logic – find the symbol for the function you want and touch that symbol – but the Symax now has new tactile buttons for an immediate, positive response.

TECHNICAL DATA

AMBIENT TEMPERATURE RANGE

CSA: Handset: 32 °F to 131 °F

CE: Handset: 0 °C to 55 °C

RADIO FREQUENCY

CSA: 915 MHz for U.S. and for Canada (Handset, Receiver)

CE: 868 MHz for Europe (Handset, Receiver)

POWER SUPPLY



Handset: 2 x 1.5V “AAA” (quality alkaline recommended)

GENERAL NOTES



Batteries – Handset

Low battery indicator on Handsets.

Software Version

Press  and  buttons simultaneously. Software version is displayed.

Handset Model Number

Press  and  buttons simultaneously. Handset model number is displayed.

Handset One Button and Two Button Ignition

Change from one button to two button ignition (Default Setting) or vice versa by pressing and holding  button for 10 sec. immediately after installing batteries. **ON** is displayed and **1** or **2** (One or Two Button Ignition) is flashing. When change is complete **1** changes to **2** or vice versa.

Deactivate Functions

1. Install batteries. All icons are displayed and flashing.
2. While the icons are flashing, press the relevant function button and hold for 10 sec.
3. The function icon will flash until deactivation is complete. De-activation is complete when the function icon and two horizontal bars are displayed.

NOTE: If a deactivated button is pressed, there is no function, and two horizontal bars are displayed.

NOTE: Deactivation remains in effect after change of batteries.

Activate Functions

1. Install batteries. All icons are displayed and flashing.
2. To activate a function, press the relevant button and hold for 10 sec.
3. The function icon will continue to flash until activation is complete. Activation is complete when the function icon is displayed.

The following Functions can be Deactivated/Activated

- CHILD PROOF
- PROGRAM MODE
- THERMOSTATIC MODE (also deactivates PROGRAM MODE)
- ECO MODE
- LIGHT/DIMMER OPERATION
- CIRCULATING FAN OPERATION
- AUXILIARY FEATURE (2ND BURNER FEATURE)
- COUNTDOWN TIMER

NOTICE

Wiring of valve and Receiver must be completed before starting ignition. Failure to do so could damage the electronics.

NOTICE

The Handsets and Receivers are not interchangeable with previous electronics.

⚠ WARNING

To avoid damaging the electronics, do NOT use metal tools to remove the batteries from the Handset/Receiver.

⚠ WARNING

- Without using a mains adapter, battery replacement is recommended at the beginning of each heating season.
- Old or dead batteries should be removed immediately. If left in the unit the batteries can overheat, leak, and/or explode.
- Do NOT expose batteries (including during storage) to direct sunlight, excessive heat, re, moisture, or severe impact. Each of these conditions can cause the batteries to overheat, leak, and/or explode.
- Batteries must be kept within their recommended temperature limits (ambient battery temperature range: 32 °F to 131 °F / 0 °C to 55 °C).
- New and old batteries and different brands of batteries should not be used together. Mixing of various batteries can cause the batteries to overheat, leak, and/or explode.

10-SYMBOL OPERATION

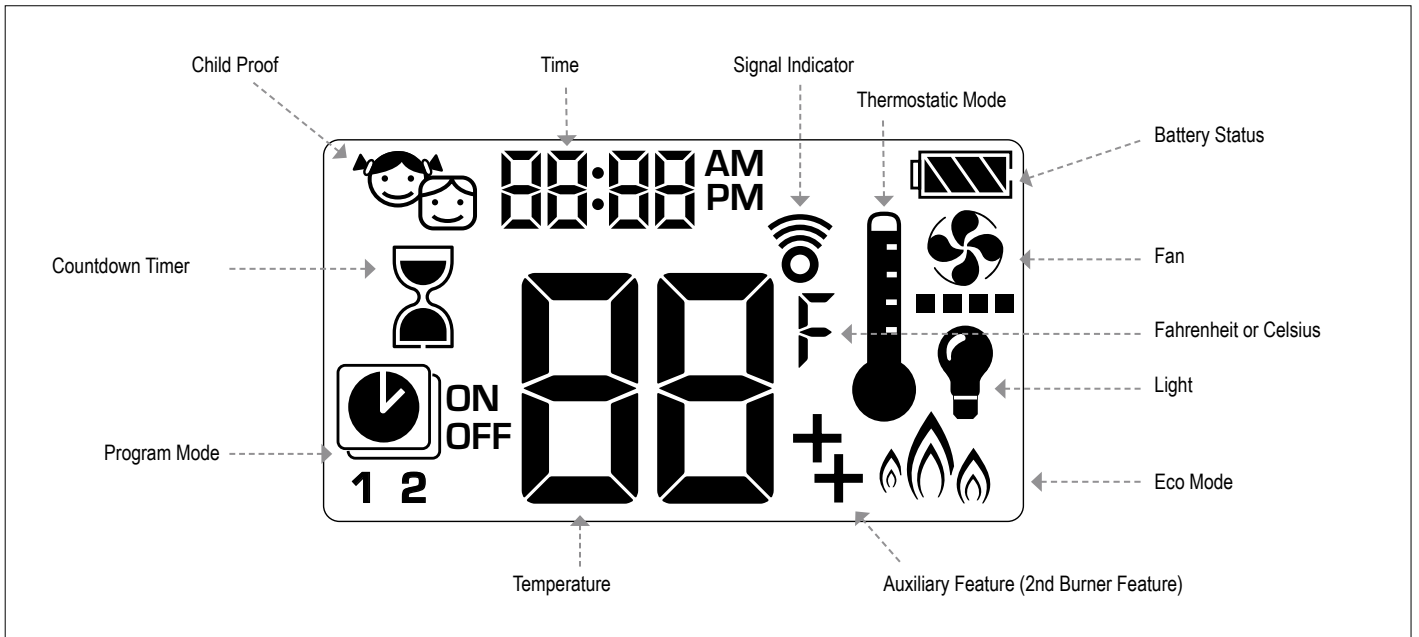
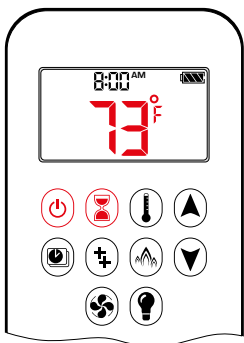

Figure 1: 10-symbol Display

SETTING FAHRENHEIT or CELSIUS



To change between °C and °F, press and buttons simultaneously.

NOTE: Choosing °F results in a 12 hour clock. Choosing °C results in a 24 hour clock.

CHILD PROOF

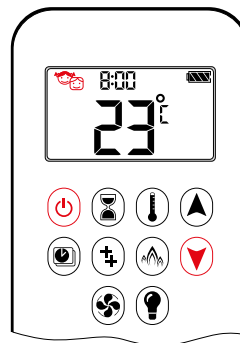

ON:
To activate press and buttons simultaneously. displayed and the Handset is rendered inoperable, except for the Off function.

OFF:
To deactivate press and buttons simultaneously. disappears.

SETTING the TIME

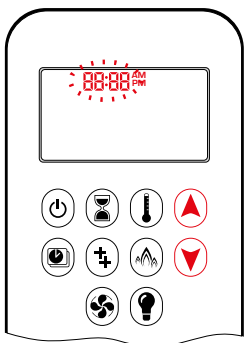

1. Press and buttons simultaneously. **Day** flashes.
2. Press or button to select a number to correspond with the day of the week (e.g. 1=Monday, 2=Tuesday, 3=Wednesday, 4=Thursday, 5=Friday, 6=Saturday, 7=Sunday).
3. Press and buttons simultaneously. **Hour** flashes.
4. To select hour press or button.
5. Press and buttons simultaneously. **Minutes** flash.
6. To select minutes press or button.
7. To confirm press and buttons simultaneously or wait.

MANUAL MODE (HANDSET)

NOTICE

BEFORE OPERATING

1. Make sure MANUAL knob on the GV60 valve is in the **ON**, full counterclockwise ↺ position.
2. Place the ON/OFF switch (if equipped) in the I (ON) position.

TO TURN ON FIRE

⚠ WARNING

When Pilot ignition is confirmed, motor turns automatically to maximum flame height.

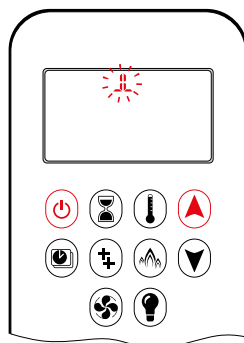

- Press ⏻ button (One Button Ignition) or ⏻ and ▲ button simultaneously (Two Button Ignition) until two short beeps and a blinking series of lines confirms the start sequence has begun; release button(s).
- Main gas flows once Pilot ignition is confirmed.
- Handset automatically goes into Manual Mode after main burner ignition.

⚠ WARNING

If the Pilot does not stay lit after several tries, turn the main valve knob to **OFF** and follow the instructions "TURN OFF GAS TO APPLIANCE"

STANDBY MODE (PILOT FLAME)

Handset

- Press and hold ⏻ button to set appliance to Pilot flame.

TO TURN OFF FIRE

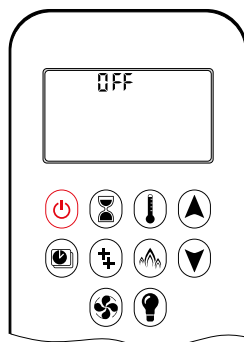

Handset

- Press ⏻ button to turn off.

NOTE: A new ignition is possible after the OFF icon stops flashing.

FLAME HEIGHT ADJUSTMENT

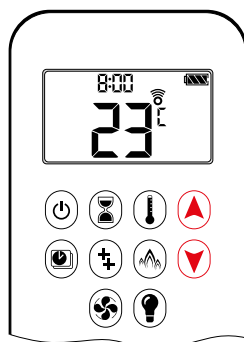

Handset

- To increase flame height press and hold ▲ button.
- To decrease flame height or to set appliance to **Pilot** flame, press and hold ▼ button.

DESIGNATED LOW FIRE and HIGH FIRE

NOTE: Backlight must be on for high fire and low fire double-click operation.

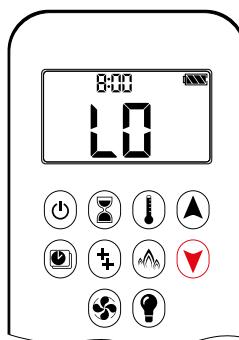

- To go to low fire, double-click ▼ button. LO is displayed.

NOTE: Flame goes to high fire first before going to low fire.

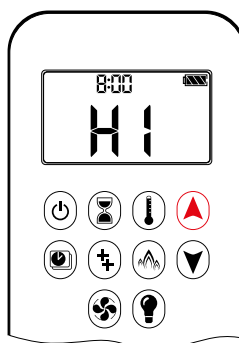

- To go to high fire, double-click ▲ button. HI is displayed.

⚠ WARNING

If the appliance will not operate, follow the instructions "TURN OFF GAS TO APPLIANCE"

COUNTDOWN TIMER

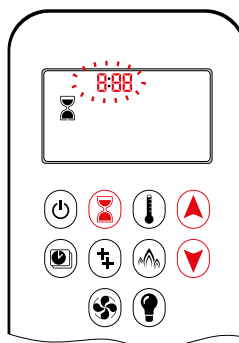

ON/SETTING:

1. Press and hold ⏻ button until ⏻ displayed, and **hour** flashes.
2. To select hour press ▲ or ▼ button.
3. To confirm press ⏻ button. **Minutes** flash.
4. To select minutes press ▲ or ▼ button.
5. To confirm press ⏻ button or wait.

OFF:

Press ⏻ button, ⏻ and Countdown Time disappear.

NOTE: At end of Countdown Time period, the fire shuts off. The Countdown Timer only works in Manual, Thermostatic, and Eco Modes. Maximum Countdown Time is 9 hours and 50 minutes.

MODES of OPERATION

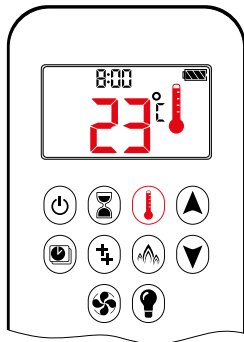

Thermostatic Mode

The room temperature is measured and compared to the set temperature. The height is then automatically adjusted to achieve the set temperature.

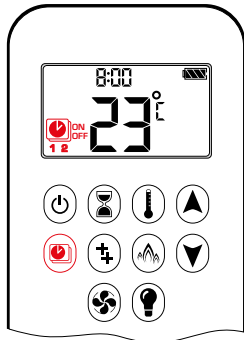

Program Mode

PROGRAM 1 and 2, each can be pro-grammed to go ON and OFF at specific times at a set temperature.

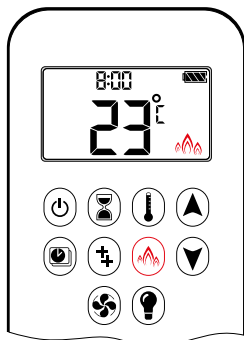

Eco Mode

Flame height modulates between high and low. If the room temperature is lower than the set temperature, the flame height stays ON high for a longer period of time. If the room temperature is higher than the set temperature, the flame height stays ON low for a longer period of time. One cycle lasts approx. 20 min.

THERMOSTATIC MODE

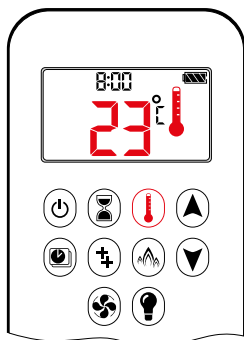

ON:

Press button. displayed, preset temperature displayed, and then room temperature displayed.

OFF:

1. Press button.
2. Press or button to enter Manual Mode.
3. Press button to enter Program Mode.
4. Press button to enter Eco Mode.

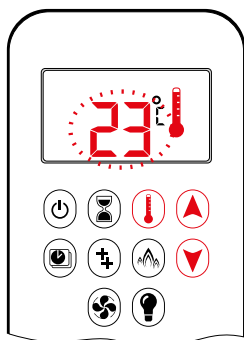

SETTING:

1. Press button and hold until displayed, temperature flashes.
2. To adjust set temperature press or button.
3. To confirm press button or wait.

PROGRAM MODE

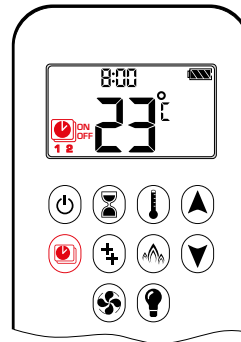

ON:

Press button. , 1 or 2, ON or OFF displayed.

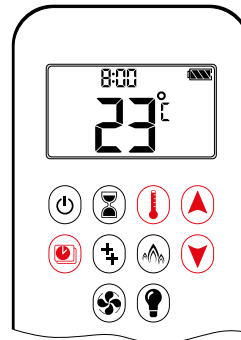

OFF:

1. Press or button to enter Manual Mode.
2. Press button to enter Thermostatic Mode.
3. Press button to enter Eco Mode.

NOTE: The set temperature for Thermostatic Mode is the temperature for the ON time in Program Mode. Changing the Thermostatic Mode set temperature also changes the ON time temperature in Program Mode.

Default settings:

ON TIME (Thermostatic) TEMPERATURE: 70 °F / 21 °
COFF TIME TEMPERATURE: "--" (Pilot flame only)

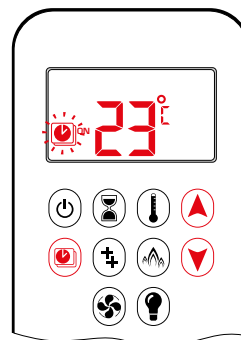

TEMPERATURE SETTING:

1. Press button and hold until flashes. ON and set temperature (setting in Thermostatic Mode) displayed.
2. To continue press button or wait. , OFF displayed, temperature flashes.
3. Select OFF temperature by pressing the or button.
4. To confirm press button.

NOTE: The ON (Thermostatic) and OFF set temperatures are the same for each day.

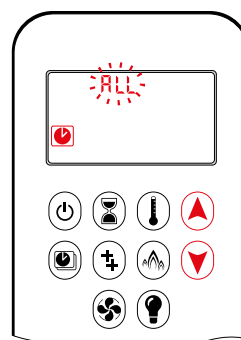

DAY SETTING:

5. ALL flashes. Press or button to choose between ALL, 5P5U, 1, 2, 3, 4, 5, 6, 7.
6. To confirm press button.

RLL SELECTED

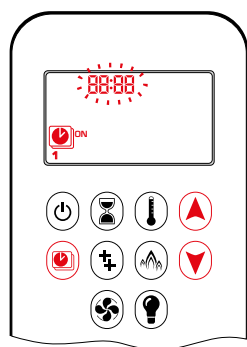

- ON TIME SETTING (PROGRAM 1):**
7. , **1, ON** displayed, **RLL** is displayed shortly, and **hour** flashes.
 8. To select hour press or button.
 9. To confirm press button. , **1, ON** displayed, **RLL** displayed shortly, and **minutes** flash.
 10. To select minutes press or button.
 11. To confirm press button.

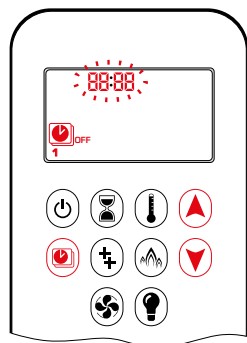

- OFF TIME SETTING (PROGRAM 1):**
12. , **1, OFF** displayed, **RLL** is displayed shortly, and **hour** flashes.
 13. To select hour, press or button.
 14. To confirm press button. , **1, OFF** displayed, **RLL** displayed shortly, and **minutes** flash.
 15. To select minutes press or button.
 16. To confirm press button.

NOTE: Either continue to PROGRAM 2 and set on and off times or stop programming at this point, and PROGRAM 2 remains deactivated.

NOTE: PROGRAM 1 and 2 use the same on (Thermostatic) and off temperatures for **RLL**, **S&S** and Daily Timer (1, 2, 3, 4, 5, 6, 7). Once a new on (Thermostatic) and/or off temperature has been set, that temperature becomes the new default setting.

NOTE: If **RLL**, **S&S** or Daily Timer are programmed for PROGRAM 1 and PROGRAM 2 on and off times, these become the new default times. The batteries must be removed to clear the PROGRAM 1 and PROGRAM 2 on and off times and temperatures.

S&S or Daily Timer (1, 2, 3, 4, 5, 6, 7) selected

- Set on time and off time using same procedure as **"RLL Selected"** (above).
- **S&S**: Set on time and off time for both Saturday and Sunday.
- **Daily Timer**: Unique on and off times may be set for a single day of the week, for multiple days of the week, or for every day of the week.
- Wait to finish setting.

AUXILIARY FEATURE (2ND BURNER FEATURE)

The latching solenoid valve will open automatically after ignition or after switching the system off, so that the maximum flow of gas is supplied to both burners assisting with the ignition process. After pressing the AUX-button the motor will turn 7 seconds in the ON direction until the max. position is reached.

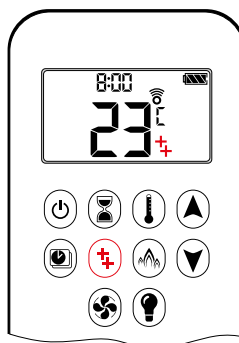

ON:
To switch a burner on, press the button. displayed.

OFF:
To switch the burner off, press the button. disappears.

NOTE: The latching solenoid valve cannot operate manually. If the Receiver battery runs down it will remain in the last operating position.

ECO MODE



ON:
Press button to enter Eco Mode. displayed.

OFF:
Press button. disappears.

CIRCULATING FAN OPERATION

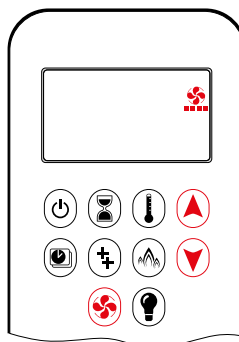

Circulating fan has 4 speed levels from low (1 bar) to high (4 bars).

- SETTING:**
1. Press button and hold until flashes.
 2. Press button to increase fan speed and button to decrease fan speed.
 3. To confirm setting either press button or wait (displayed).

OFF:
Press button until all 4 speed level bars disappear.

NOTE: SETTING only. If the fan was not switched off after last use, it starts automatically 4 minutes after ignition at maximum speed and goes to the last set level after 10 seconds. The fan stops 10 minutes after the gas is OFF or at Pilot.

THE PUCK

LIGHT/DIMMER OPERATION

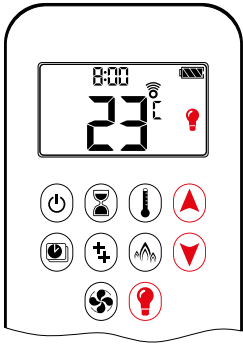

ON:
Press button (displayed). Light is on at preset level.

OFF:
Press button (disappears).

SETTING:

1. Press button and hold until flashes.
2. To adjust light between 20...100% press or button.
3. To confirm setting either press button or wait (displayed).

NOTE: The Light works independently of the Pilot flame. If you want the light on but no flame, press button.

PROCONTROL APP

NOTICE

Before the app can be used, the Wi-Fi Box must be wired and plugged into mains power according to ProControl App Setup diagram (and the App Setup must be completed).

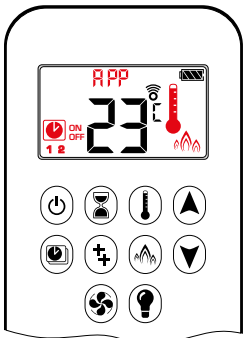

If Thermostatic, Program or Eco Mode is activated, the corresponding icon and "RPP" is displayed on the Handset.

The modes can be operated according to the descriptions on previous pages.

NOTE: In Manual Mode "RPP" is NOT displayed on the Handset.

The Puck is a smart control that works in conjunction with the GV60/Symax system. Its basic functions include turning the fire on and off and turning the flame height up and down.

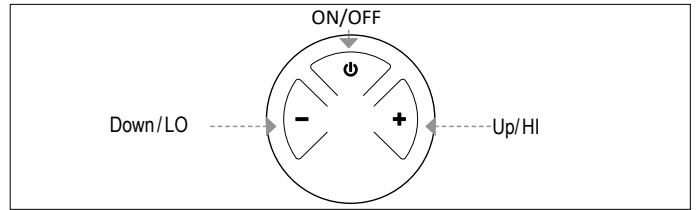

Figure 2: Lay-out 3 Buttons

TECHNICAL DATA

AMBIENT TEMPERATURE RANGE

CSA: The Puck: 32 °F to 131 °F
CE: The Puck: 0 °C to 55 °C

RADIO FREQUENCY

CSA: 915 MHz for U.S. and for Canada (The Puck, Receiver)
CE: 868 MHz for Europe (The Puck, Receiver)

Power Supply

Handset: 2 x 1.5 V "AAA" (qualitative alkaline recommended)

NOTICE

Wiring of valve and Receiver must be completed before starting ignition. Failure to do so could damage the electronics.

NOTICE

The Handsets and Receivers are not interchangeable with previous electronics.

⚠ WARNING

To avoid damaging the electronics, do NOT use metal tools to remove the batteries from the Handset/Receiver.

⚠ WARNING

- Without using a mains adapter, battery replacement is recommended at the beginning of each heating season.
- Old or dead batteries should be removed immediately. If left in the unit the batteries can overheat, leak, and/or explode.
- Do NOT expose batteries (including during storage) to direct sunlight, excessive heat, re, moisture, or severe impact. Each of these conditions can cause the batteries to overheat, leak, and/or explode.
- Batteries must be kept within their recommended temperature limits (ambient battery temperature range: 32 °F to 131 °F / 0 °C to 55 °C).
- New and old batteries and different brands of batteries should not be used together. Mixing of various batteries can cause the batteries to overheat, leak, and/or explode.

SYNCHRONISATION HANDSET/RECEIVER

1. Insert batteries or connect AC mains power. The module for circulating fan and light/dimmer includes a mains adapter. With mains adapter, batteries can be used for backup.
2. Place ON/OFF switch (if equipped) to **ON** position.
3. The Receiver has to learn the Handset code:
 Press and hold the Receiver's reset button (see figure 19, page 11) until you hear two (2) beeps. After the second, longer beep, release the reset button. Within the subsequent 20 seconds press the  button on the Handset. Two (2) short beeps confirm the code is set. "E0:##" is displayed on the Handset confirming the synchronization is in process (see figure 13). After successful synchronization the current state of the gas fire is displayed on the Handset.

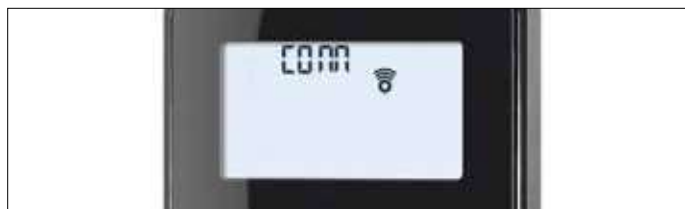

Figure 3: Synchronization in process

- NOTE:** This is a one time setting only, and it is not required after changing the batteries in the Handset or Receiver.
- NOTE:** Both the Receiver and the Handset transmit and receive signals (bidirectional). Handset and Receiver sync status information every 10s during first 2 min – afterward every 4 to 6 min up to 1 h. Touching a Handset button causes an immediate synchronization.
- NOTE:** When the RF Receiver is placed in the appliance, the surrounding metal can reduce reception considerably.



MODES OF OPERATION

⚠ WARNING

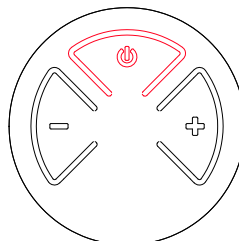
When Pilot ignition is confirmed, motor turns automatically to maximum flame height.



TURN FIRE ON AND OFF

- Press and hold the  button until two short beeps confirms the start sequence has begun; release button.
- Main gas flows once Pilot ignition is confirmed.
- Handset automatically goes into Manual Mode after main burner ignition. 
- Press the  button to turn off.

⚠ WARNING

If the Pilot does not stay lit after several tries, turn the main valve knob to **OFF** and follow the instructions "TURN OFF GAS TO APPLIANCE" (see page 9).

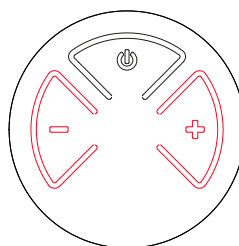

FLAME HEIGHT ADJUSTMENT

- To increase flame height press and hold **+** button.
- To decrease flame height or to set appliance to Pilot flame, press and hold **-** button.

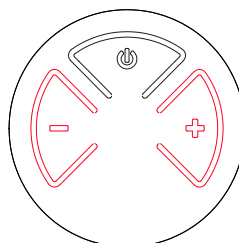

DESIGNATED LOW FIRE AND HIGH FIRE

- To go to low fire, double-click **-** button.
- NOTE:** Flame goes to high fire first before going to low fire.
- To go to hi fire, double-click **+** button.

⚠ WARNING

If the appliance will not operate, follow the instructions "TURN OFF GAS TO APPLIANCE"

WI-FI BOX

A new version of the Wi-Fi Box has been created. The improvements include faster processing speed, new Wi-Fi chip, and best of all for the customer, an uncomplicated and much shorter App Setup menu for the ProControl app. The new Wi-Fi Box also has variable power supply between 5 and 24 volts, two RGB outlets, identical connectors on both ends of the cable, and the Wi-Fi Box itself has a much smaller footprint for easy installation in tight spaces.

TECHNICAL DATA

AMBIENT TEMPERATURE RANGE

CSA: myfire Wi-Fi Box: 32 °F to 140 °F
CE: myfire Wi-Fi Box: 0 °C to 60 °C

RADIO FREQUENCY

CSA + CE: 2.4 GHz

Power Supply

Wi-Fi Box: 6V connection to the Receiver which is connected to an AC mains adapter.

WI-FI BOX

- WPA2 authentication
- AES 256-bit encryption security
- Compatible with IEEE 802.11n/g/b

CONSUMPTION OF ELECTRICITY

CSA+CE: Nominal: max. 0.5W
CSA+CE: Standby: max. 5mA

LED RGB CONTROL OUTPUT

CSA + CE: Phoenix, 3 pol, MC 1.5/3-ST-3.5,
5VDC - 24VDC / 5Amps

LED RGB EXTERNAL POWER INPUT

CSA + CE: Phoenix, 2 pol, MC 1.5/2-ST-3,
5VDC - 24VDC / 5Amps

MODES OF OPERATION

The Wi-Fi Box allows communication with a home network (Wi-Fi Router) over a wireless signal.

1. Wi-Fi Box must be wired according to the ProControl App Setup diagram
2. Wi-Fi-Box must be connected to the Receiver; connect Receiver to mains power. The Wi-Fi Box starts with the Access Point Mode (green light flashes) if no home network is configured. Go to "myfire App Setup"

MINIMUM REQUIREMENT WI-FI ROUTER:

- Compatible with IEEE 802.11n/g/b
- WPA2 encryption
- Radio frequency: 2.4 GHz band
- Wireless auto channel: Automated search for WLAN radio channel free of interference
- Support for the User Datagram Protocol (UDP)
- Connection to mDNS is required to guarantee Easy Commission Process
- One temperature sensor

MINIMUM REQUIREMENT SMART DEVICE:

- IOS 8.0 or Android 4.2

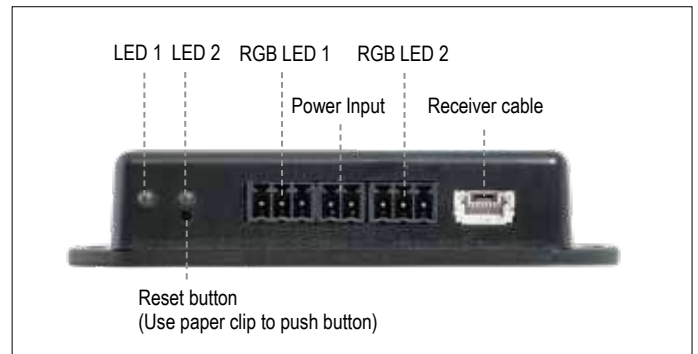

Figure 4: Wi-Fi Box version 2 connections

LED INDICATION ON WI-FI BOX

2 RGB LEDs with 3 colors red / green / blue

Label	Status	Status
(LED 1) Receiver	Green	Connected to Receiver.
	Red	Not connected to Receiver.
	Off	Standby mode is active. No Power supply.
(LED2) WLAN	Green	Wi-Fi connection is safe.
	Blue blinking	Access point mode is active.
	Red	Not connected to home network (Wi-Fi Router).
	Off	Standby mode is active. No power supply.

RESET STATUS ON MYFIRE WI-FI BOX:

Press Reset Button	LED message	Function
Power-On-Reset or 1-sec-Reset	Flashing green and blue	If no network is set, the AP Mode will be activated for 2 hours. When the network isn't set after 2 hours, the Wi-Fi Box will change into Standby Mode 1. Once a network is set, the Wi-Fi Box will connect directly.
10 secs	Receiver LED flashes every 500ms in blue	Removes the Wi-Fi settings and turns on the P Mode for 2 hours.
20 secs	Receiver LED flashes every 50ms in blue	Erases all Setup Data. The Wi-Fi chip will be set to the last version after the reboot. The AP-Mode will be activated for 2 hours.

NOTICE

- A handset or **The Puck** must be used to achieve full functionality.
- If mains power is lost, disconnect the Wi-Fi Box from the Receiver. This will prevent Receiver batteries from being drained quickly.
- Multiple users on the same Wi-Fi channel may interfere with the data transfer. Press reset button on the Wi-Fi Box for 1 second to change current channel (see figure 24).
- If Wi-Fi Box is not connected to the Receiver or is not used, it will leave the Access Point Mode (AP Mode) after 2 hours.
- If you have multiple fireplaces using Wi-Fi Boxes, the minimum distance between the Wi-Fi Boxes must be 60 cm (2'). A shorter distance may interfere with the data transfer.

▲ WARNING

Do not connect the combination control system to the LED connections of the Wi-Fi Box.

MYFIRE WI-FI BOX (B6R-W2...) RGB LED'S AND LED DRIVER

TECHNICAL DATA

RGB LED WORKING VOLTAGE RANGE
5-24 VDC

SUPPORTED RGB LED COUNT PER RGB-CHANNEL
300

MAXIMUM CABLE LENGTH WI-FI BOX TO LED-STRIP
2 meter

LED outputs support the requirements of WORLDSEMI
WS28xx RGB controller family

REQUIREMENTS FOR EXTERNAL LED DRIVER

The LED Driver has to be selected according the voltage and required current consumption of the RGB-LEDs. There are two different possibilities to connect them:

Direct connection via Wi-Fi Box ($\leq 5 A$):

- 5-24 VDC / max. 5A on LED RGB external power input
- The power has to connect to the LED RGB external power input of the Wi-Fi Box. (see figure 5, page 24)

Indirect connection (>5A)

- 5-24 VDC direct from the LED driver to the LEDs
- Connection of data output (DO) and ground (GND) from the LED RGB control output of the Wi-Fi Box to the RGB LEDs. (see figure 6)

NOTICE
There is no standard for RGB LED controller. Therefore, the RGB LEDs or RGB LED-stripes have to be tested for functionality. The color sequence can be different from the RGB, e.g. GRB. The sequence can be adjusted in the myfire app.

NOTICE
The Wi-Fi Box is designed according to the requirements of the EMC-directive 2014/30/EU and FCC/IC requirements. Third party devices and the wiring can change the electromagnetic compatibility behavior. It is the OEM's responsibility to have the appliance approved in accordance to all required standards and laws.

NOTICE
Electrical wiring has to be designed according to the power consumption and supplier recommendation of RGB-LED's. At a mini-mum of 24 VDC/5A a cross section of 0.5mm²/AWG 20 is recom-mended, for data wires flexible wires are recommended. All wires should have UL conformity and temperature rating accordingly.

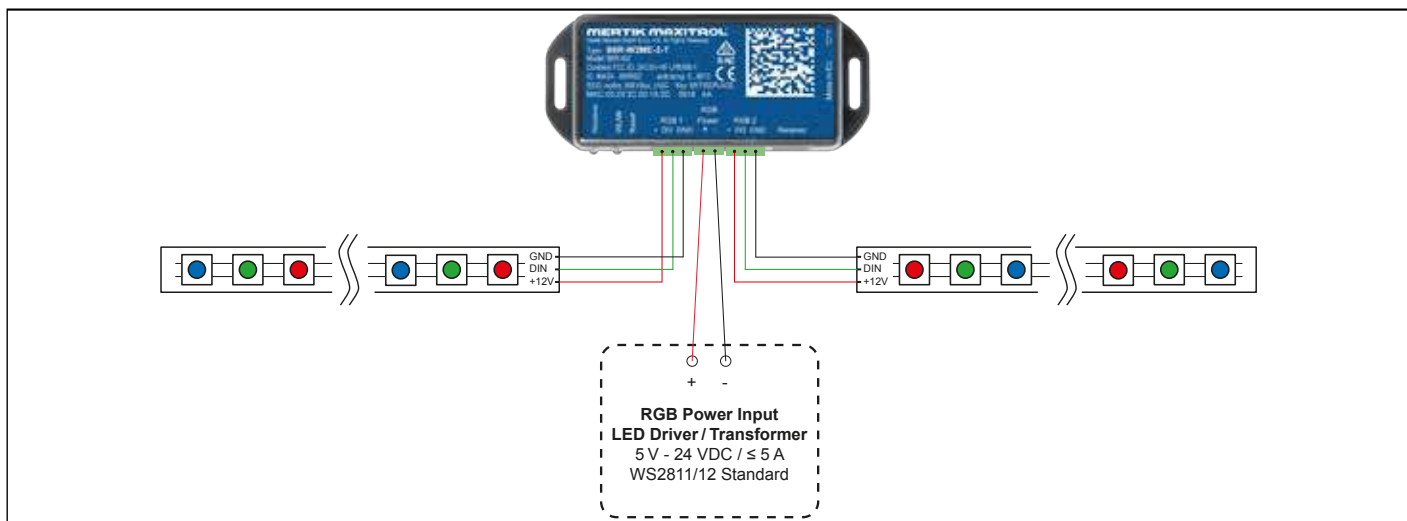

Figure 5: LED setup 1

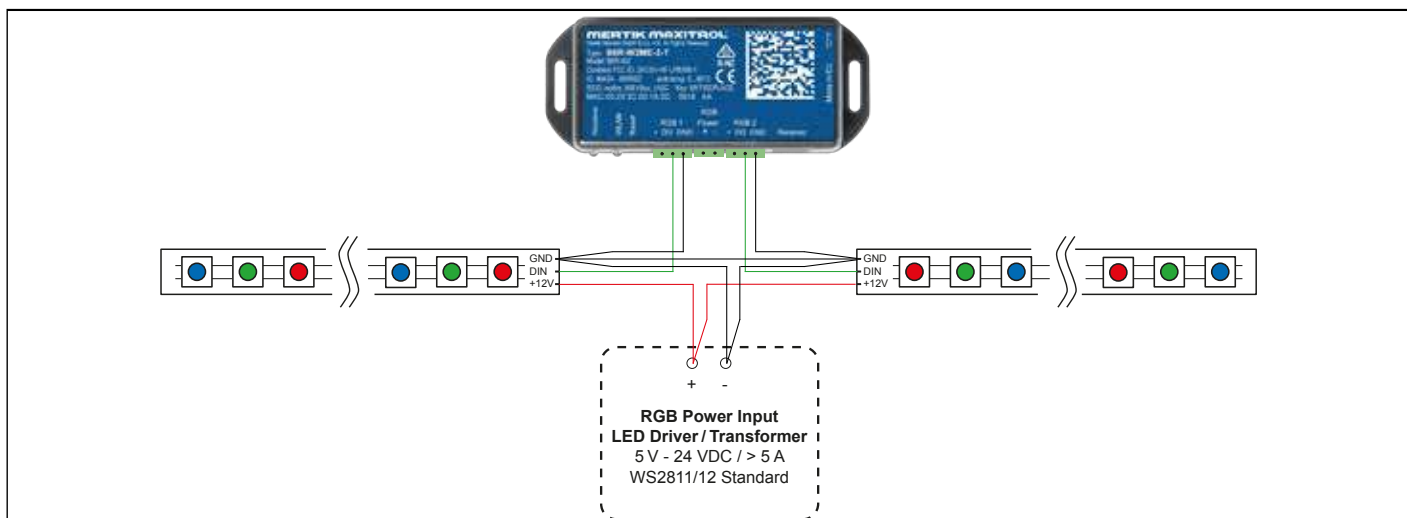

Figure 6: LED setup 2

PROCONTROL APP SETUP

NOTICE

For ProControl App Setup, you will need your Wi-Fi network SSID and password.

INITIAL SETUP

1. Download ProControl app from Apple App Store or Google Play Store.
2. Touch screen to start App Setup.
3. Choose language, temperature (°C or °F) and time format (12 or 24 hour).

REGISTRATION

NOTE: You must register before logging in. Registration is one time only.

1. Fill in data and accept the "Privacy Policy".
2. Touch "OK" in pop-up notice.
3. Touch link to confirm email verification.
4. You will be shown a message that you have successfully registered the ProControl app.
5. Return to app.

LOGIN

1. Fill in your registration password.
2. Accept "Terms and Conditions".
3. Touch the "Login" button.

KWIK CONNECT

CONNECT THE SMART DEVICE TO THE WIFIBOX

1. Touch the icon.
2. The name of the home WiFi network that your device is currently connected is displayed.
3. Enter the password of the displayed home WiFi network.
4. Press 'Connect'. The ProControl app starts the connection of the Wi-Fi Box to the Wi-Fi network.

COMPLETE THE PROCONTROL APP SET-UP

1. Enter a name for your fireplace or select an icon.
2. Activate the fan, the light and the AUX function if installed on your stove.
3. Press 'Finish' to complete the setup.
The home screen is displayed and the ProControl app is ready or use.

STANDARD SETUP

IF KWIK CONNECT IS NOT AVAILABLE AND YOU HAVE ENTERED THE RIGHT PASSWORD, USE THE STANDARD SETUP.

1. Enter the password for the displayed home WiFi network.
2. Follow the instructions on the screen and touch the touch button "Standard setup" to continue.
3. Go to the Wi-Fi settings of your intelligent device and select the Wi-Fi Box network (myfire_WiFi-Box_ <number>) with which you want to connect.
4. Go back to the ProControl app set-up and follow the instructions on the screen. Select network name for the wifibox from the Wi-Fi settings of your smart device.

USE "TRY AGAIN" IF THE PASSWORD IS INCORRECT.

The home screen is displayed and the ProControl app is ready to go.

NOTICE

To connect Wi-Fi Box to Wi-Fi Router (home network), make sure:

- Home network is available.
- Home network name and password are correct.
- SSID of the Wi-Fi Router is not hidden.
- Home network signal is in range.
- Wi-Fi Router supports User Datagram Protocol (UDP).

NOTICE

- After setting up the Wi-Fi Box and ProControl app, the time has to be synchronized in the settings of the ProControl app.
- The active device (Handset or smart device) is the one last used. An exception is if the non-active device is used to change Light, Fan, or AUX. The non-active device will make the changes, but the active device remains so if it is in Thermostatic, Program, or Eco Mode. If a Profile includes a Thermostatic, Program, or Eco setting it will also cause the active device to remain active.
- If Thermostatic, Program, or Eco Mode is activated using the app, the corresponding icon and "APP" is displayed on the Handset (see figure 28).
- During motor movement no information between Receiver and transmitter is exchanged. The synchronization follows after motor has stopped.
- The room temperature data is transferred by the Handset during synchronization.



Figure 7: App connected (in Thermostatic Mode)



Paxtonstraat 23
8013 RP Zwolle
The Netherlands

+31-(0)38 420 90 20
info@element4.nl

JULY 2019